

JINP40
Precision Industry Co., Ltd.

Integrated
Engineering &
Manufacturing

jpp-KY
TWSE:5284

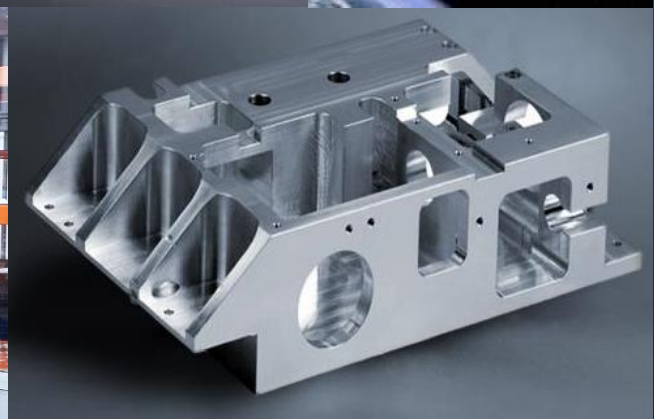
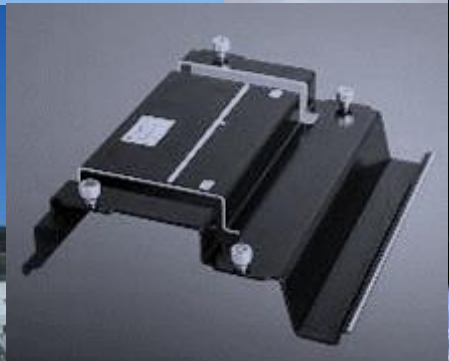

全球布局

2 strategic poles



EUROPE



AGILITEAM
BY JINPAO

JINPAO



BANGKOK



Year : 2023

ASIA

EUROPE



60M

10M

USD



1200

106



1

3

Introducing History & milestones

模具設計製造

投入自動化板金、智慧製造

跨入航太

台灣上市

成立歐洲團隊

AGiLiTEAM 跨入航太MRO

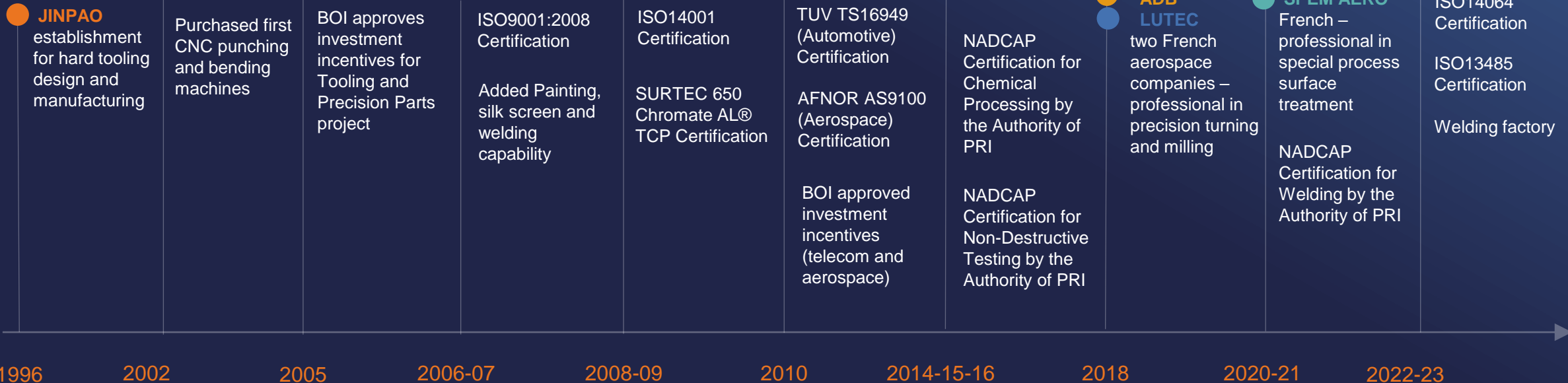

營運分布
Key figures

Year : 2023



40~42%
Aerospace



45~47%
Tele-comm



7%
Electronic



2%
Food



1%
Automotive



1%
Health-care

MANUFACTURE

NCT Punching, Laser, Bending, 3/4/5 Axis CNC Machining, Stamping, Hard Tooling, Hydroforming

SPECIAL PROCESS

Anodizing, Chemical Conversion Coating, Primer & Painting, Powder Coating, Bonding Non-Destructive Testing, Welding, Heat Treatment,

SPECIAL PROCESS SUBCONTRACTORS

Boric Acid Anodizing, Sulfuric Acid Anodizing, Hard Anodizing, Chromate Conversion, Electroless Nickel Plating, Chrome Plating, Nickel Plating, Cadmium Plating, Silver Plating, Bronze Plating, Tin Plating, Zinc Plating, Passivation, Heat Treatment, Die Casting



1%
Energy

競爭優勢
價值整合

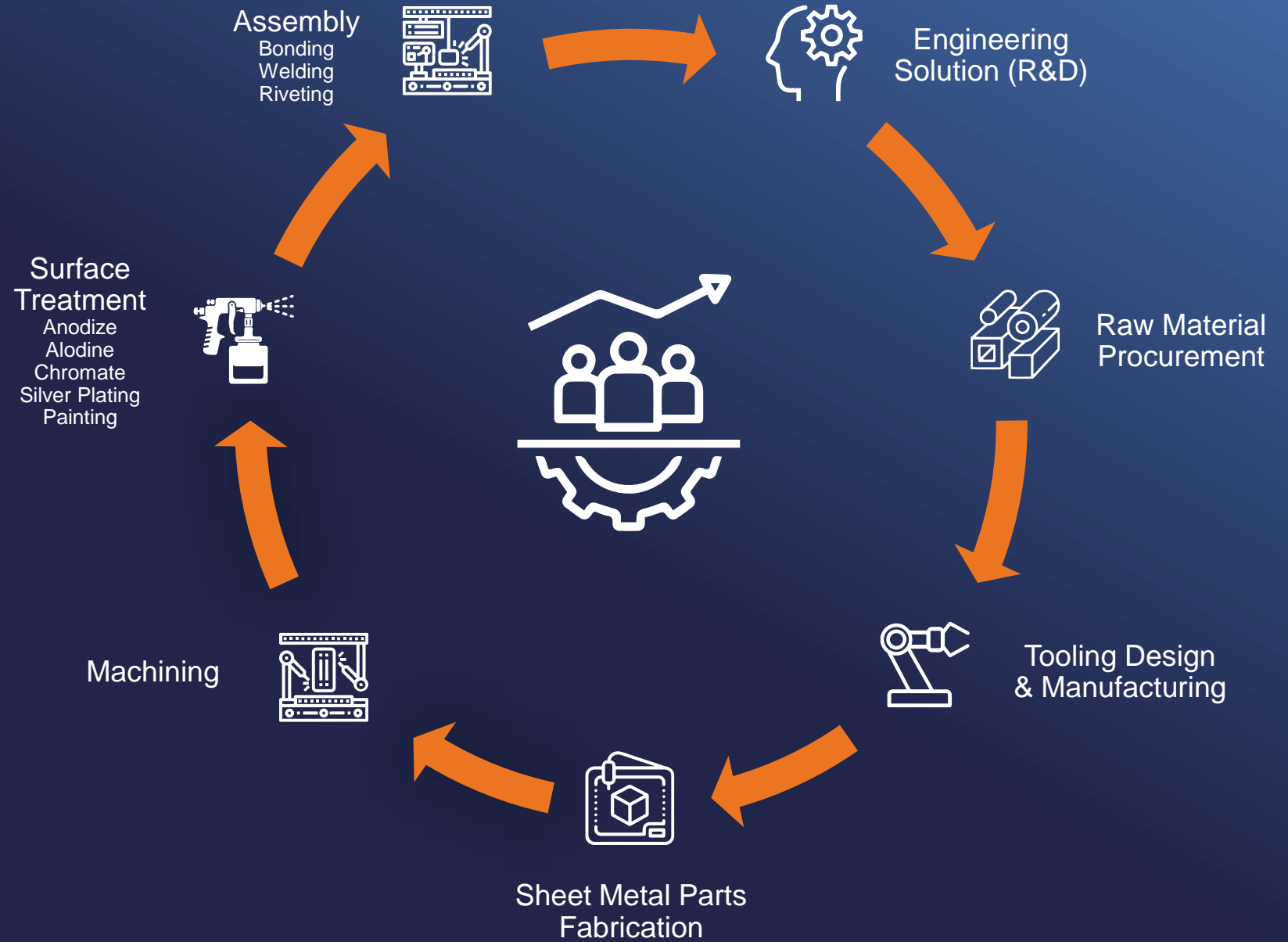

MATERIAL TYPE

Aluminum, Stainless Steel,
Inconel, Copper Alloys,
Nickel Alloy, Titanium

Plate, Sheet, Bars, Extrusion, Die
Casting

製造工藝
Processes

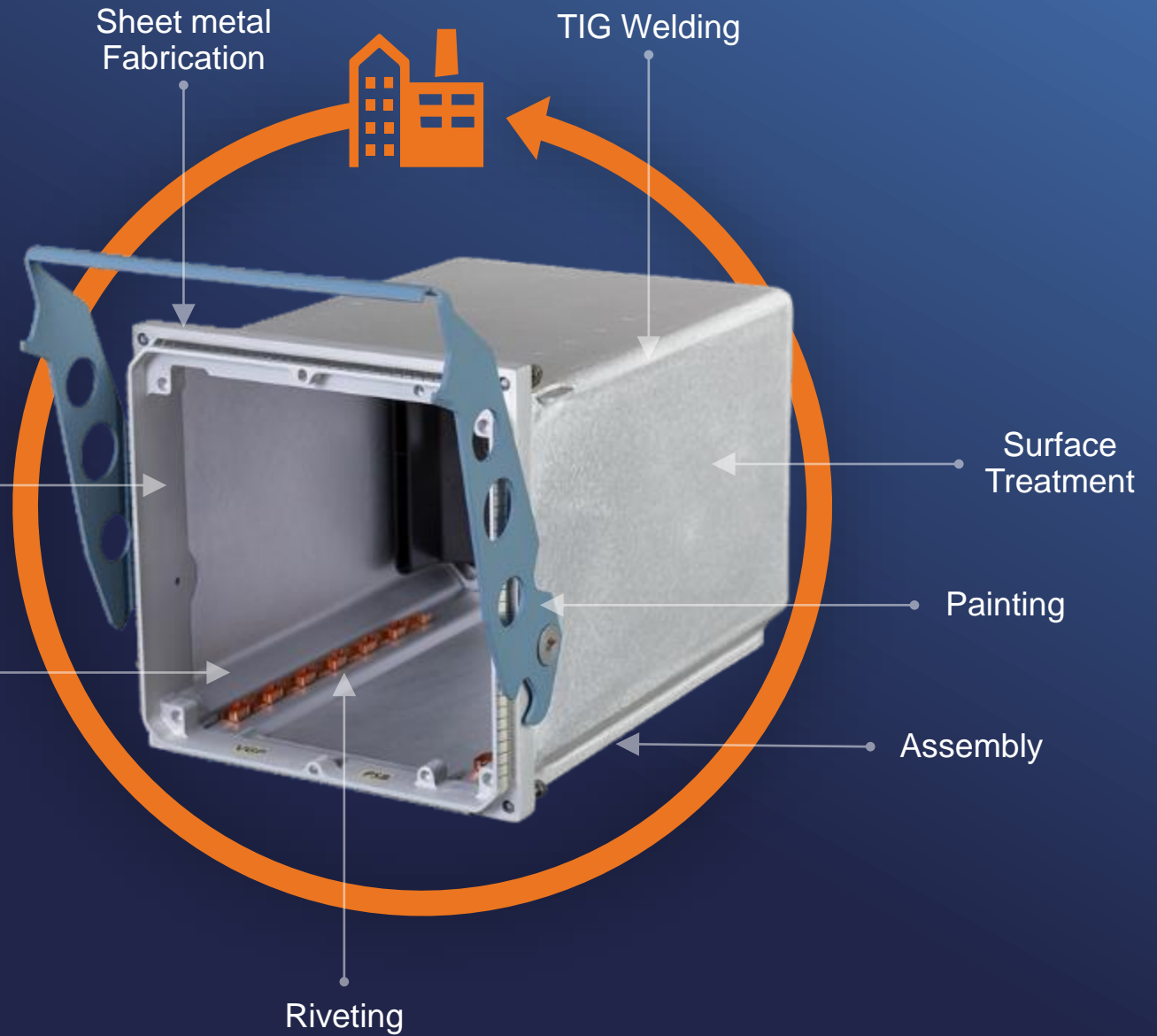

OUR CERTIFICATIONS



ISO 14001
ISO /IATF 16949



Welding
Chemical Processing
Non-Destructive Testing
Heat Treating

New



Factory 4.0 Framework

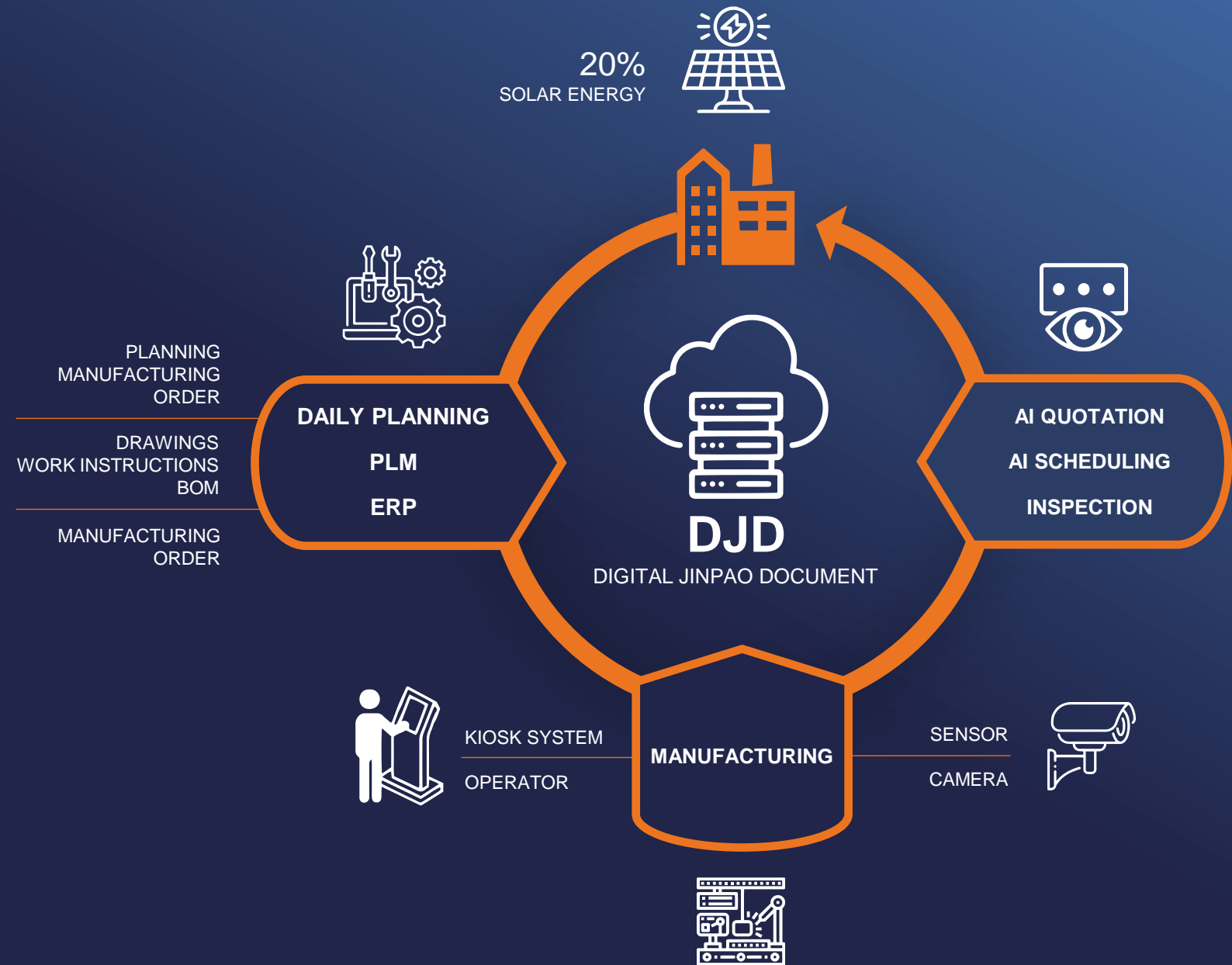

FACTORY 4D TOUR





YOUR global partner

Custom Mechanics
High-Mix
Low-Volume

非航太產品



Integration Assembly

DESIGN AND MANUFACTURE

value-added assembly solution for
plug-and-play tested units
(included testing after integration)

- Telecommunication Cabinets
- Entertainment Products
- Infrastructure Devices
- IoT Devices
- Kiosks terminals



Electronic
Cabinet

Vending
terminal

5G control
Cabinet



Model PCB

Data Center



抱桿櫃

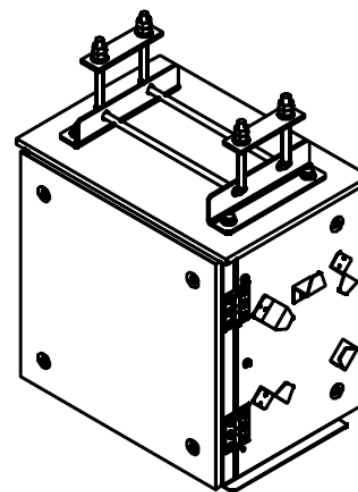

柱上開閉器子装置

遊戲機



汽車相關

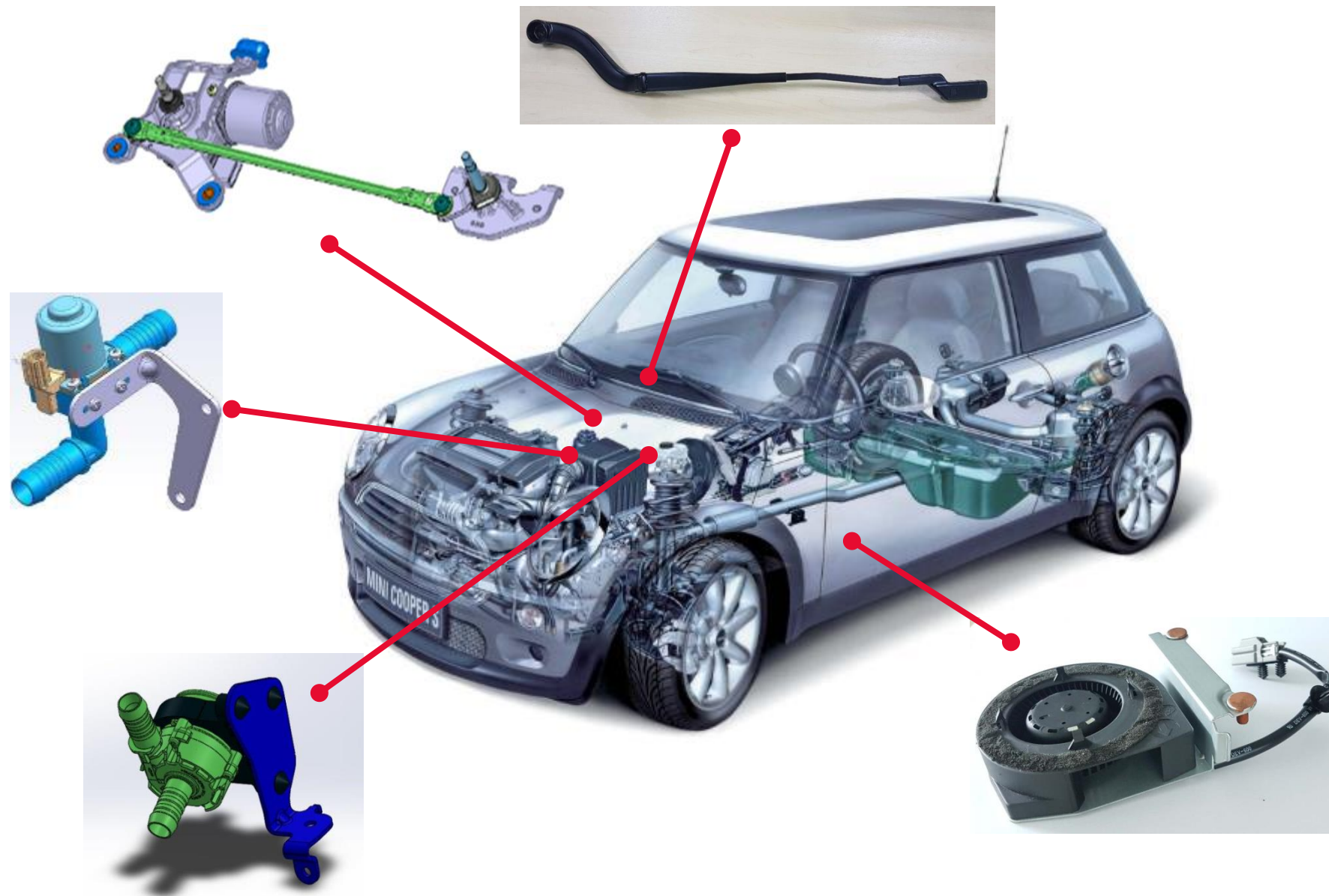

智慧醫療



食品工業



TECHNOLOGY AND FOOD SAFETY

JINPAO provide manufacturing of equipment for Automotive industry, included:

- food scanners
- vending machines
- X-Ray Metal Checker
- Automatic Combination Weightier
- Milk Analyzer





YOUR global partner





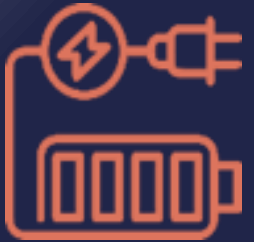

Custom Mechanics
High-Mix
Low-Volume

新能源領域

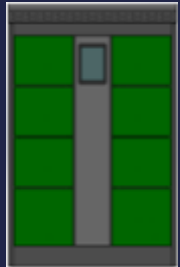

研發過程

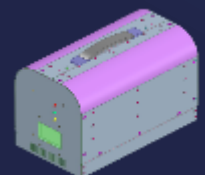
History & milestones

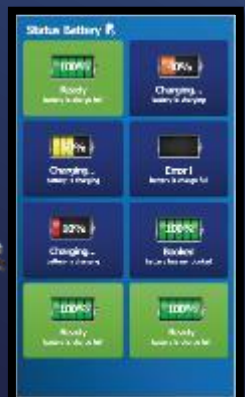
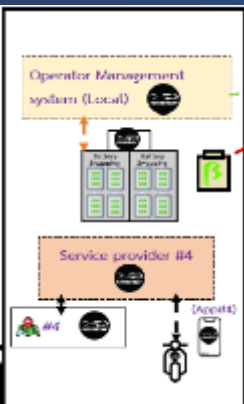
<p>JINPAO</p> <ul style="list-style-type: none"> - Concept -Original Design Manufacturer 	<p>JINPAO & Outsource</p> <ul style="list-style-type: none"> - R&D on battery related topics -Design of electronic part -Develop Application & Control 	<p>JINPAO</p> <p>Assembly & Install to Cabinet.</p> <ul style="list-style-type: none"> -Cabinet. -Wiring diagram. - Built in program. 	<p>JINPAO</p> <p>Test for the efficiency of charging the battery.</p> <ul style="list-style-type: none"> -Temperature. -Cost of charge. 	<p>JINPAO</p> <p>API for creating platform.</p> <ul style="list-style-type: none"> -Payment. -Parameter of Battery. 	<p>JINPAO</p> <p>Battery charger development</p> <ul style="list-style-type: none"> -Low cost. -Open parameter. -Communicate in RS232 format. 	<p>JINPAO & Outsource</p> <ul style="list-style-type: none"> -R&D on multi-voltage charge topics -Design of electronic part -Optimized by experts Design of electronic part -Develop Application & Control 	<p>JINPAO</p> <p>API for creating platform.</p> <ul style="list-style-type: none"> -Payment. -Parameter of Battery. Update display to show battery charging parameters -Trial Run. 	<p>JINPAO for NSTDA</p> <ul style="list-style-type: none"> - Concept -Original Design Manufacturer -Developed a multi-voltage battery charging system. 	
2021 Feb	2021 Mar	2021 Apr	2021 May	2021 Jun	2021 Dec	2022 Feb Mar	2022 Jun	2022 Jul Aug	2023

Electric scooter



Vapor

- Design in Thailand
- Made in Thailand

Vapor

COLOR OPTIONS



Charger and Swapping stations

Energy



FEATURE AND SPECIFICATION

RFID / Scan payment
Full charging time : 1~5 hours
(depend on type of battery)
Charging power :
72V 40A max 2880W
Charge 2 battery / station
Charge status indicator and alert sound.



Swapping stations (NSTDA)

National
Science and
Technology
Development
Agency



Swapping stations (HONDA)

Global SPEC





YOUR global partner

Custom Mechanics
High-Mix
Low-Volume

航太産業



Aerospace



Aerospace Products





Aerospace Products

Electrical Flight Control System Computers Enclosures

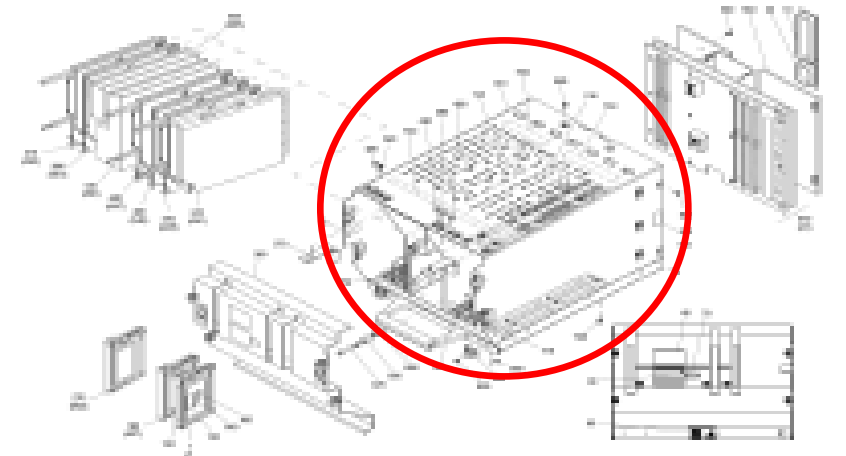
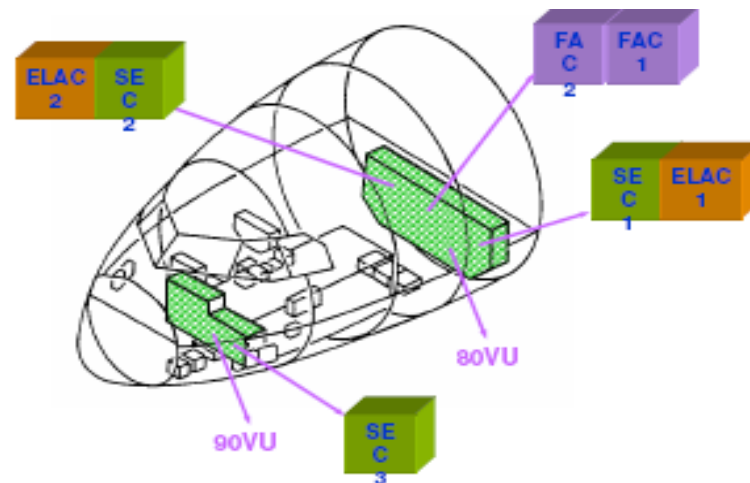

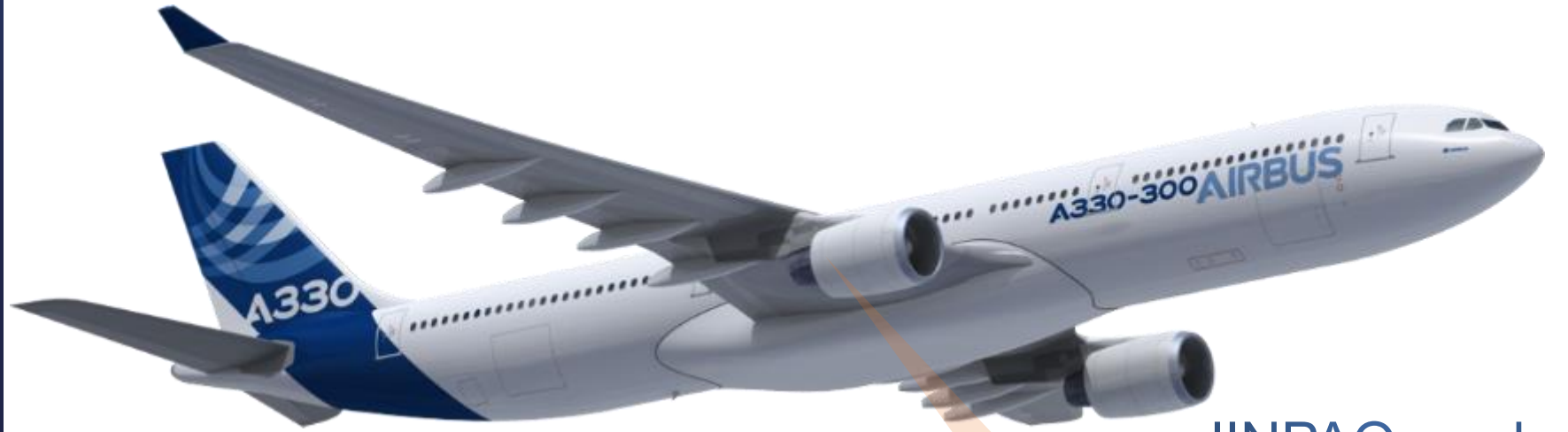

JINPAO produce
sheet metal parts
for airplane
engine

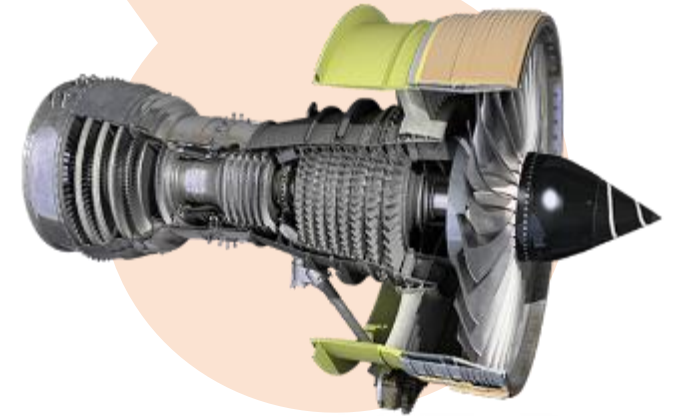

Trent-700 (Rolls-
Royce)



THEOS-2

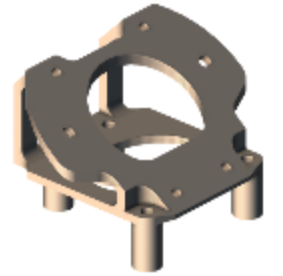
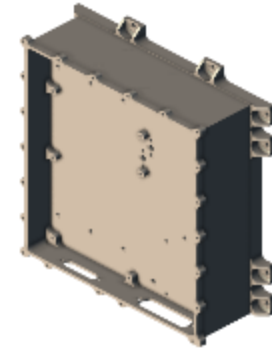
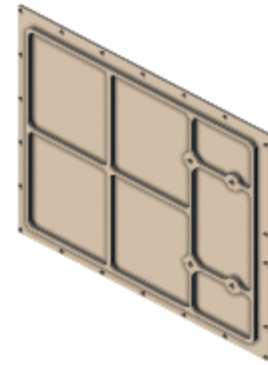

Star Tracker
Interface Bracket
(Titanium)

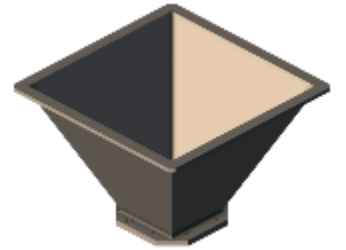
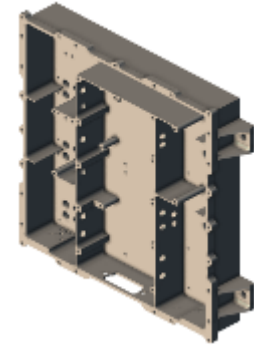
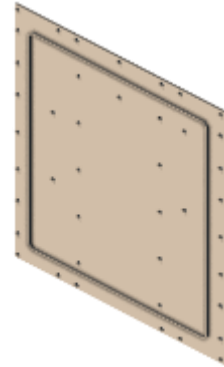

X-Band Horn
Antenna (Aluminum)





YOUR global partner

Custom Mechanics
High-Mix
Low-Volume

未來展望

今年重點目標 **Non-Aerospace**
明年重點目標 **Aerospace**

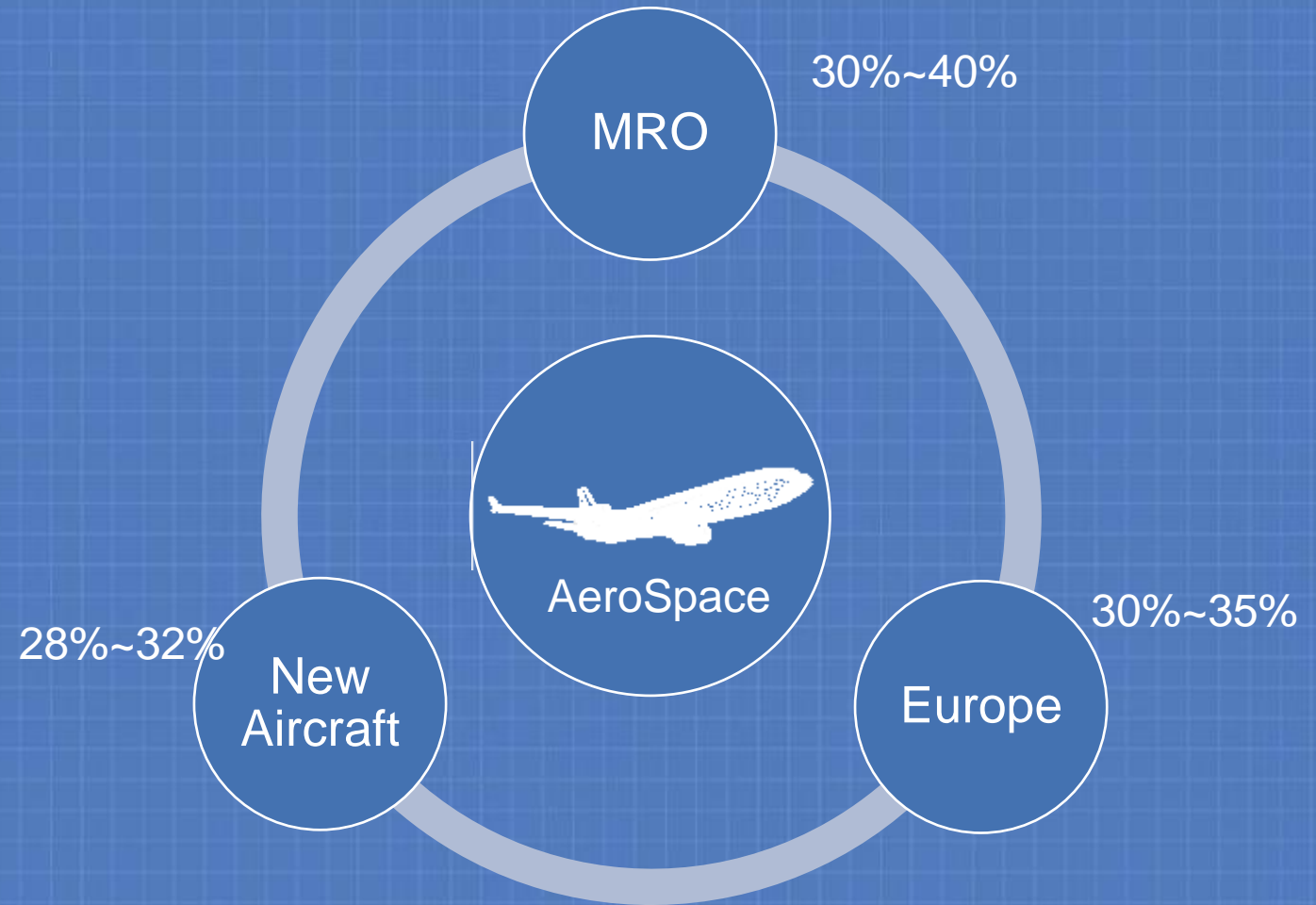

現有專案機型

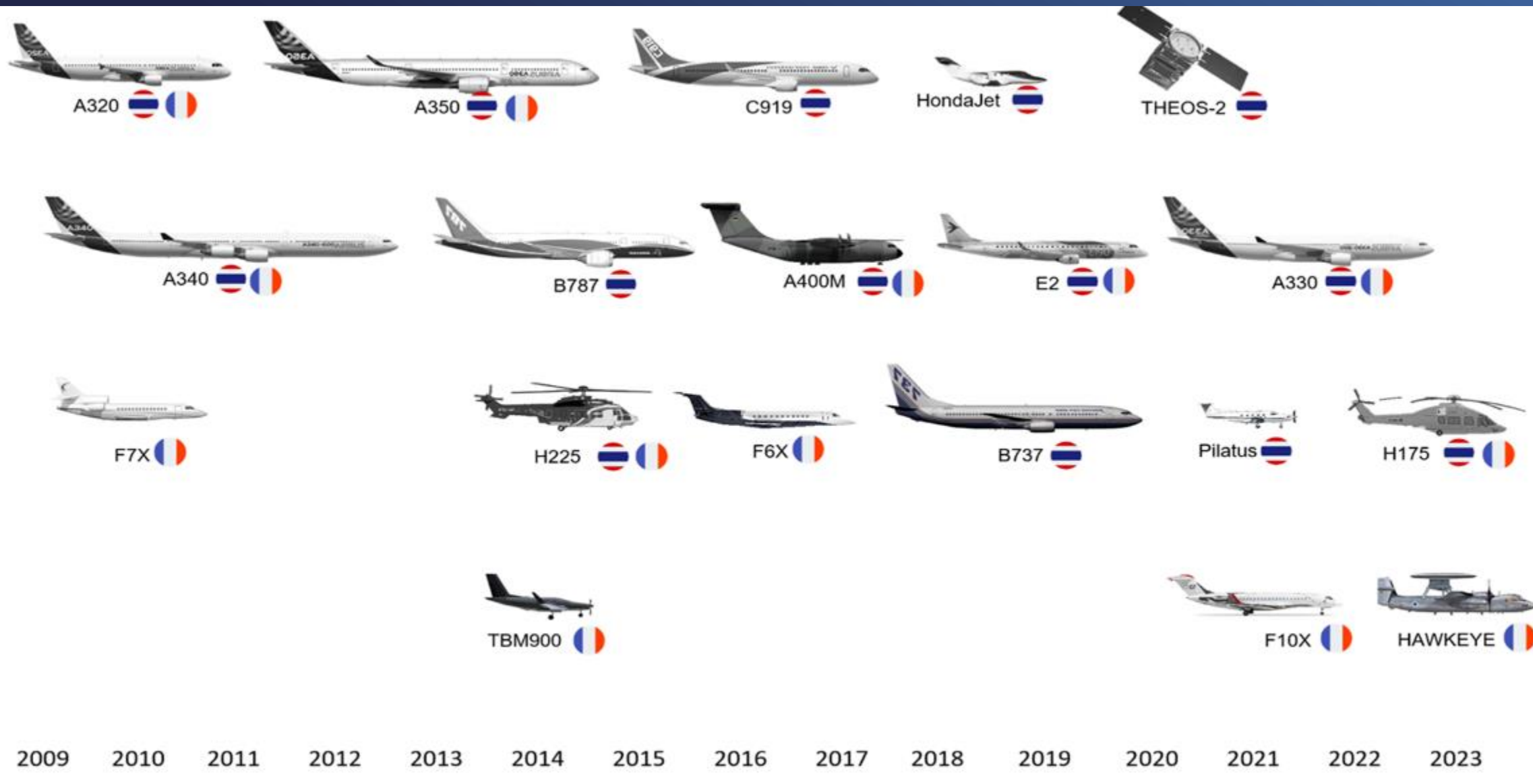

今年新客戶
及目標產品

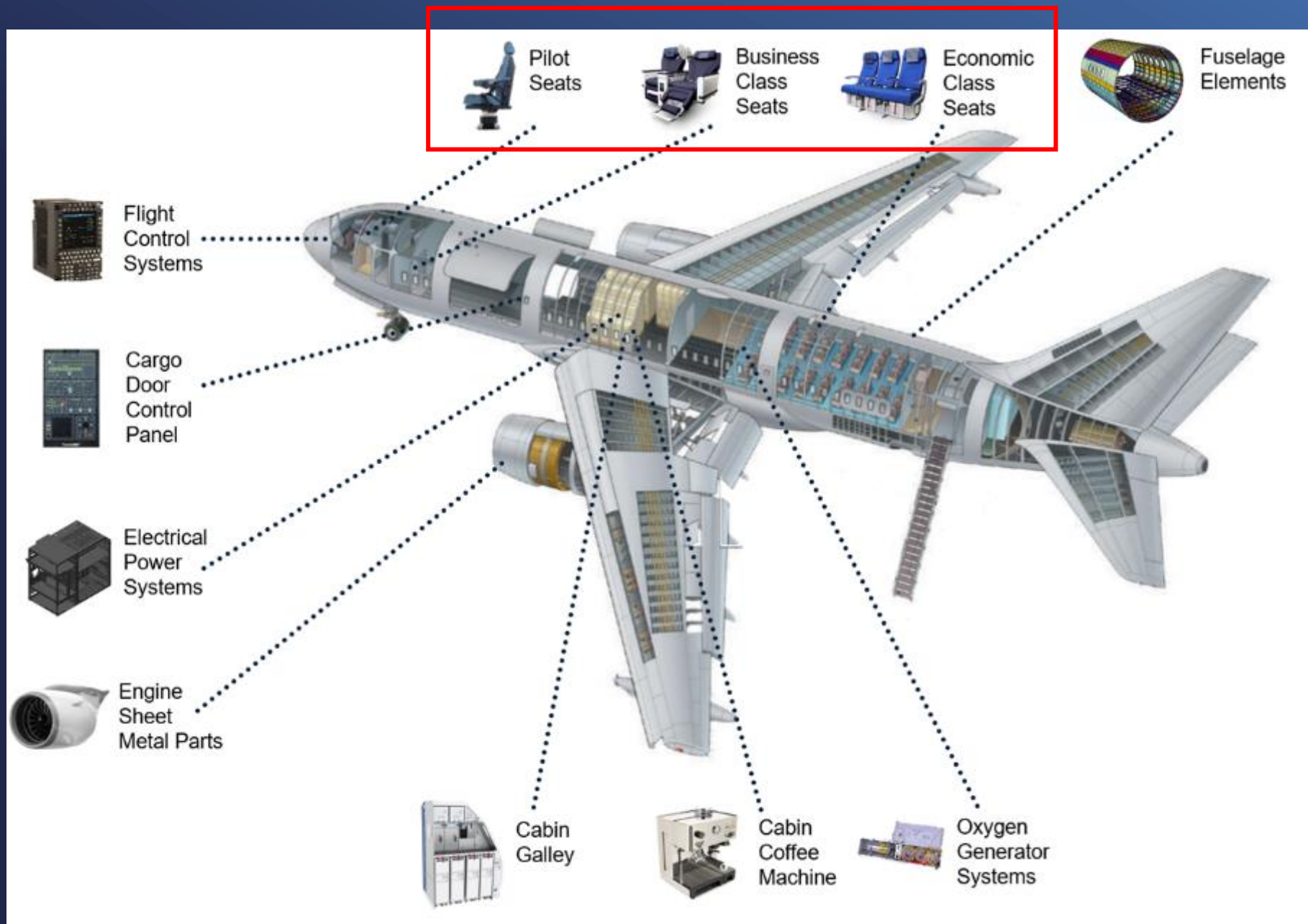

EASA CERTIFIED DOMAIN

Wefly is an international aviation training academy. A Thai-Italian cooperation program, partnered with EASA Certified Organisations.

- EASA Part-147
- EASA DOA, POA
- EASA Part-145, CAMO
- EASA ATO

- EASA Part-145
 - Part-145 Approval is a company level certification to the European Commission Regulation standards of design, production, Maintenance, Repair and Overhaul of aircraft (MRO).

- EASA Part-147
 - Part-147 is the certified EASA training organization that regulates the approval of maintenance training organisations.

- EASA ATO
 - An ATO is an Approved Training Organisation. They are approved to deliver flight & maintenance training.

- EASA CAMO
 - Continuing airworthiness management organisation (CAMO) is a civil aviation organisation authorized to schedule and control continuing airworthiness activities on aircraft and their parts.

- EASA DOA
 - DOA is a design organisation (approval) responsible for the design of aircraft, related parts and appliances, and for changes or repairs. design approvals.

- EASA POA
 - POA is a production organisation approval.



維修改裝



維修改裝



Mordor Intelligence 預估 2023~2028 商用飛機 MRO市場將從742億美元規模成長至941億美元，複合年均成長率4.88%

AGILITEAM
BY JINPAO

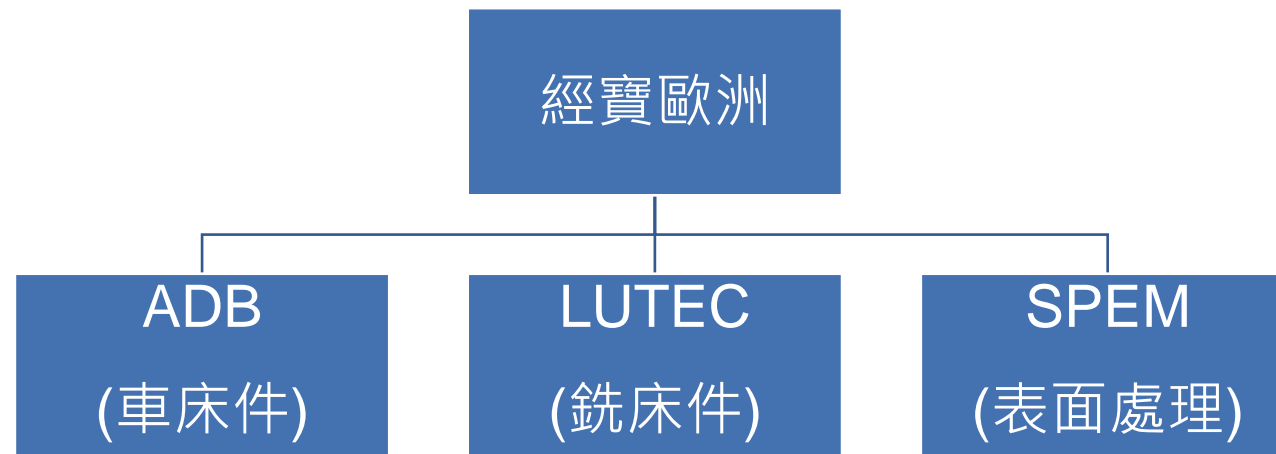

Data Center

-Rack

42U

48U

48U Open Rack

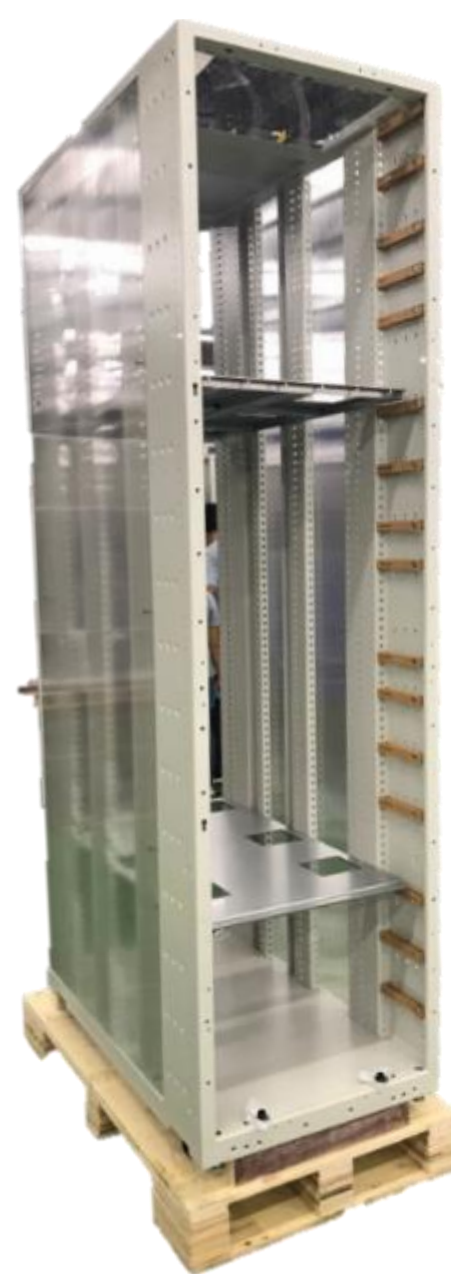

Data Center

- Server

- 1U
- 2U
- 3U

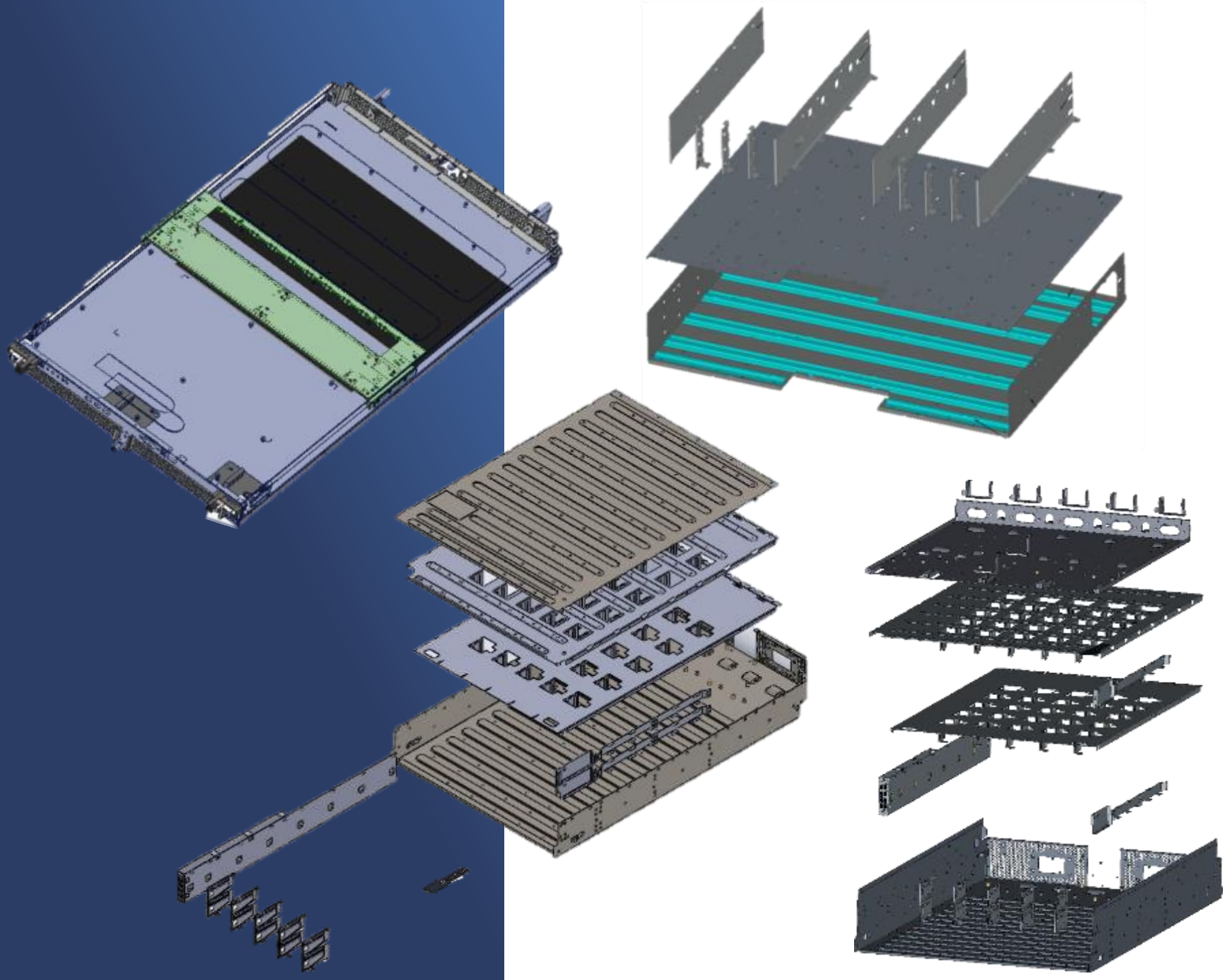

Data Center -Manifold and Rack (Front Side)

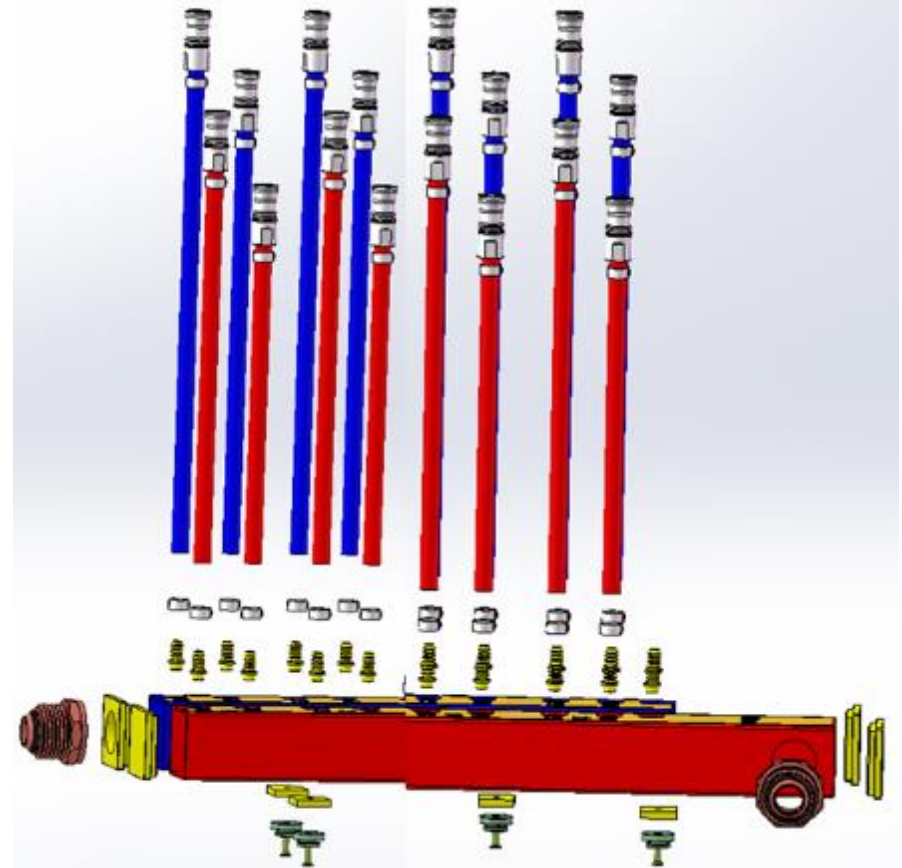
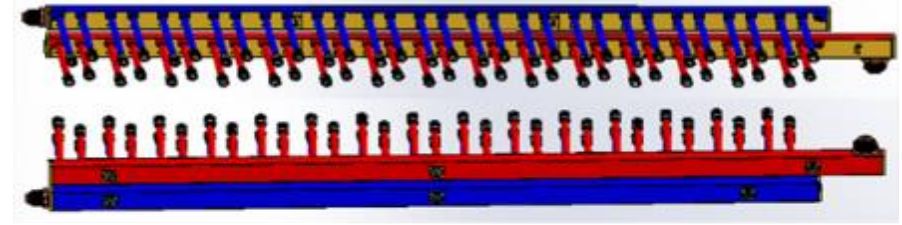

Data Center

-Manifold and Rack
(Back Side)

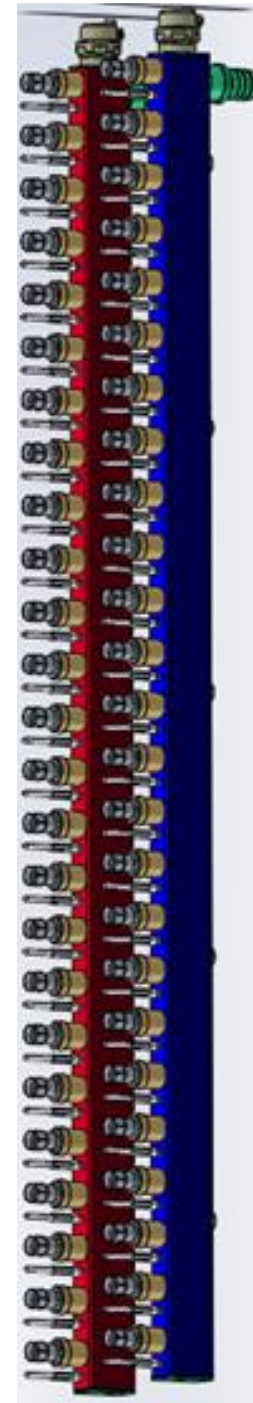
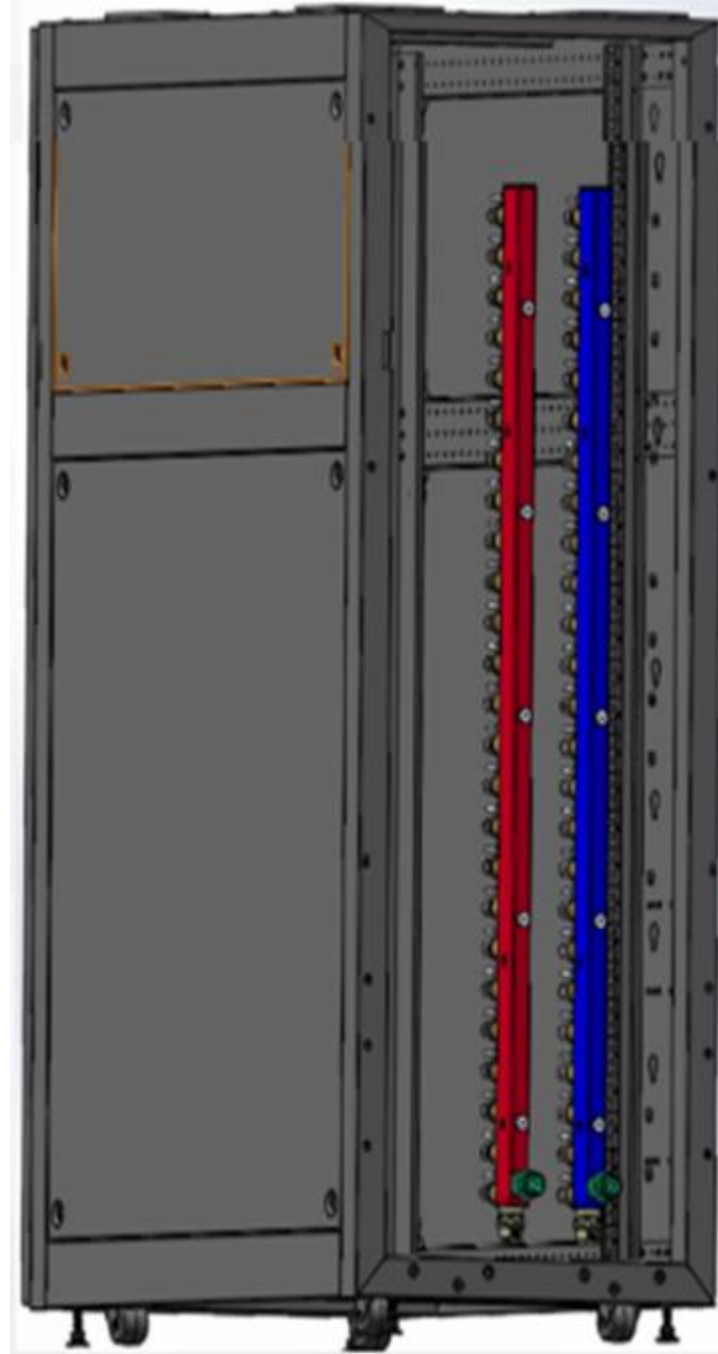

Data Center

-Manifold and Rack

(Top Side)

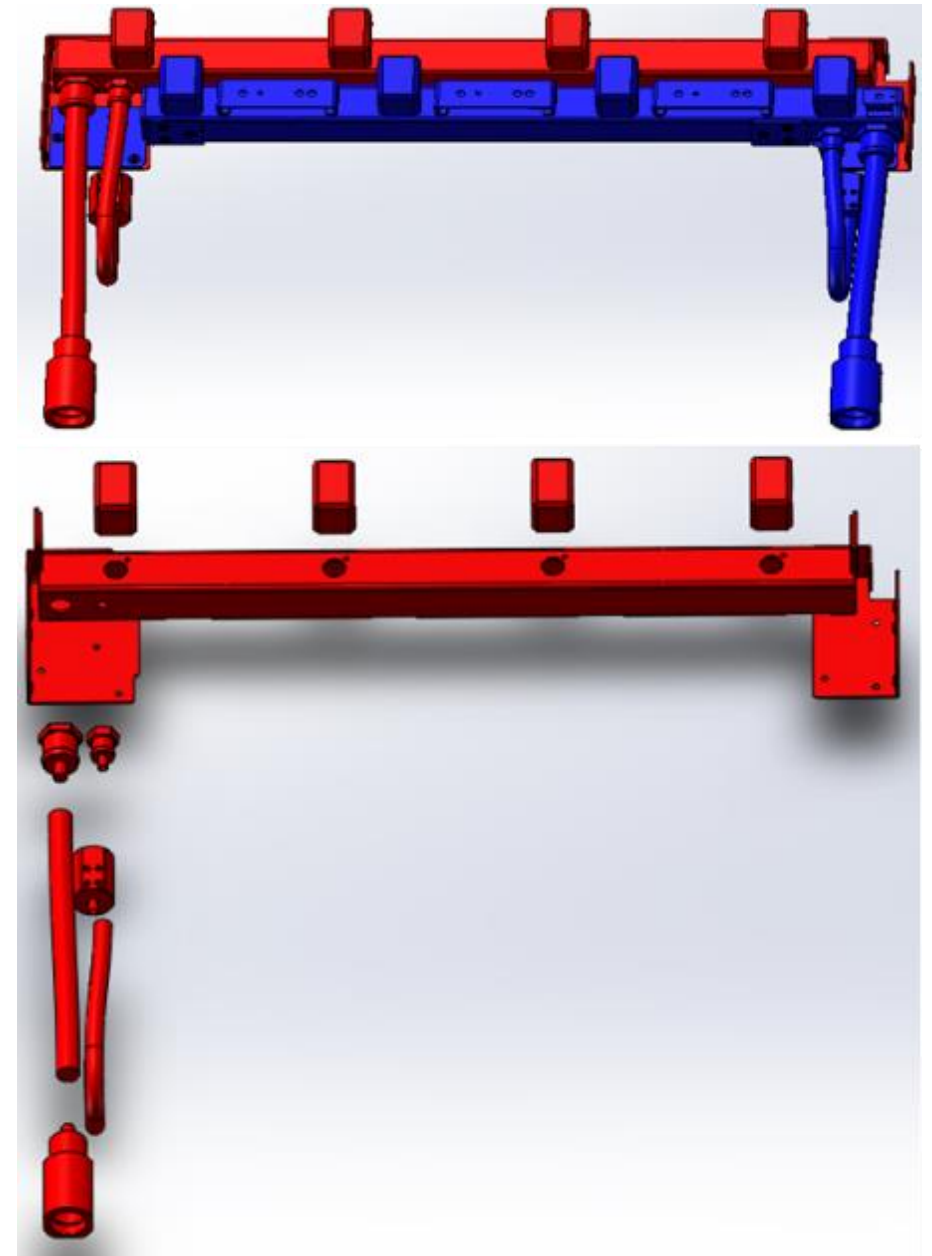
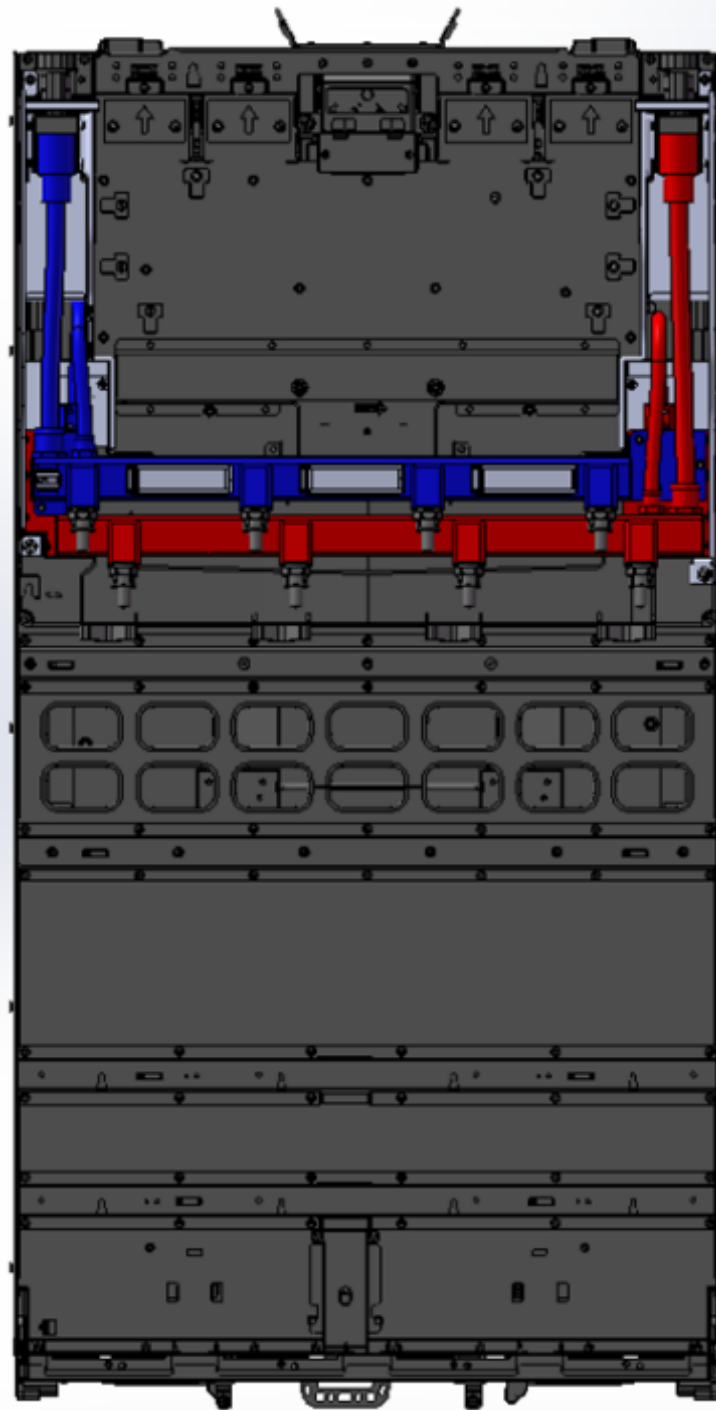

TAOBIN

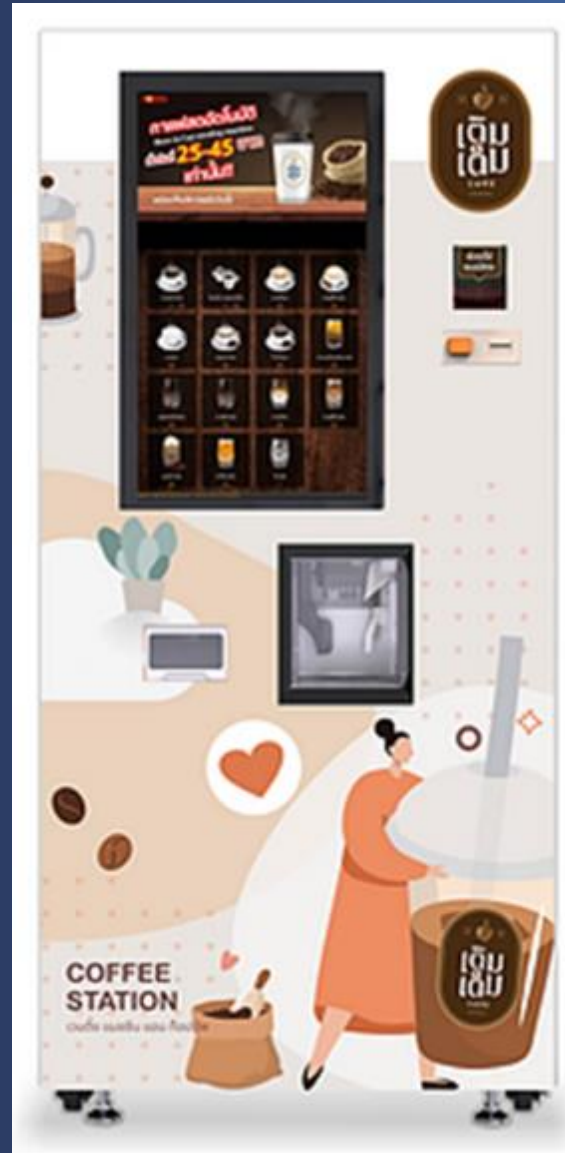

工廠產能規劃



2022 新廠



2023
新建電鍍研磨廠



未來規劃

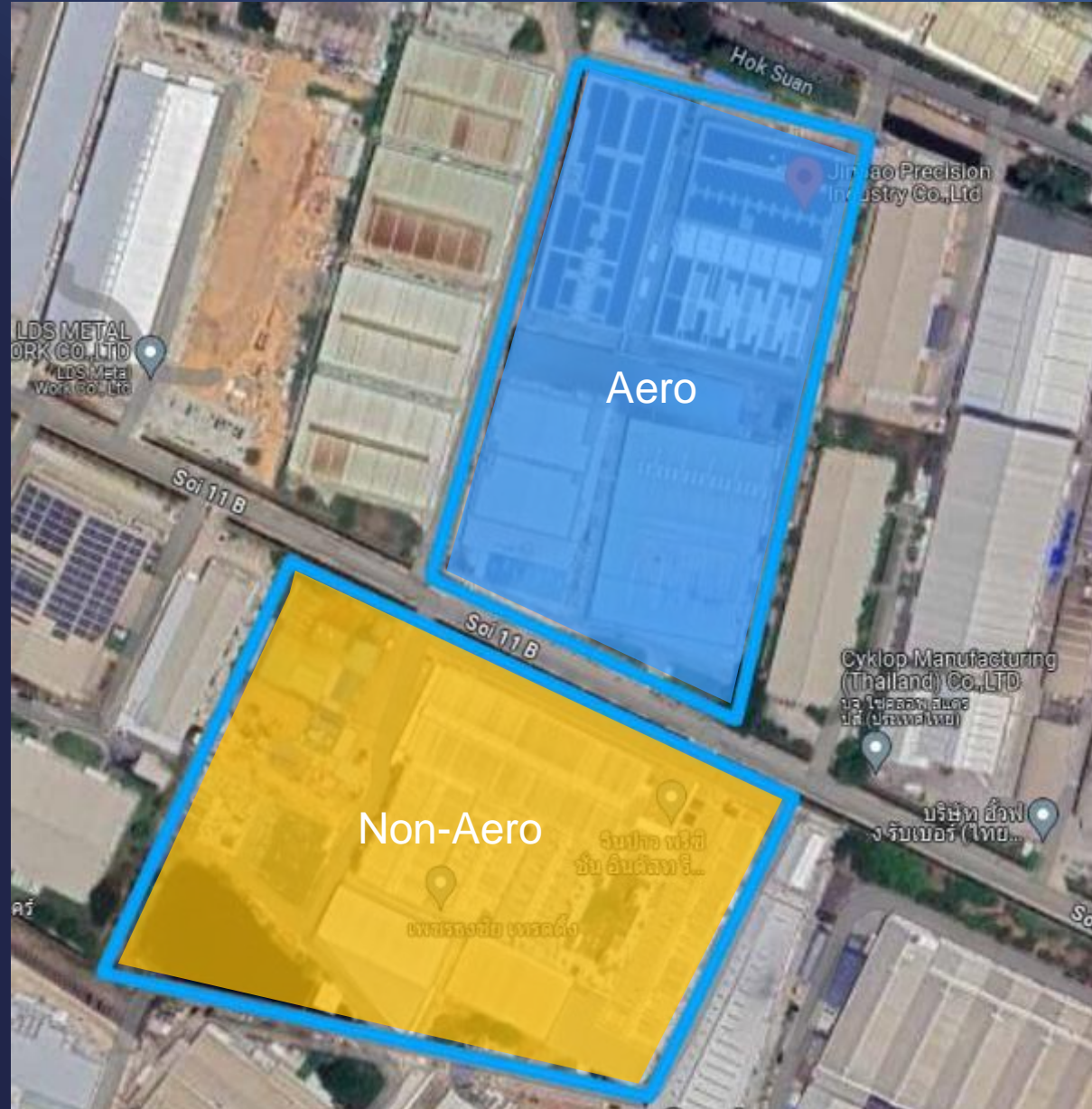



THANK YOU